

POWERFLOW™ HP COMBI

310–600 ML CARTRIDGE & SACHET

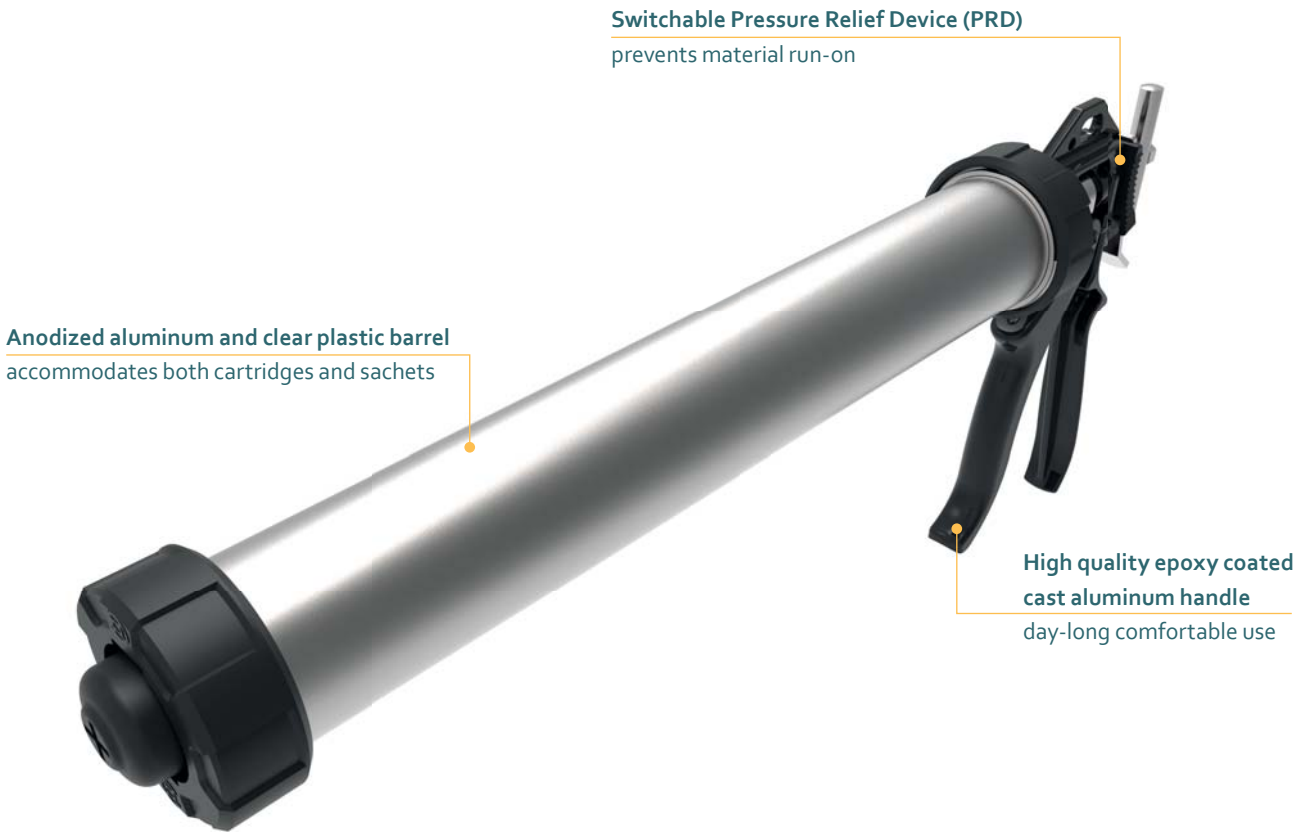

Switchable Pressure Relief Device (PRD)
prevents material run-on

Anodized aluminum and clear plastic barrel
accommodates both cartridges and sachets

High quality epoxy coated cast aluminum handle
day-long comfortable use

Model shown: PowerFlow HP Combi 600 mL

FEATURES

- High quality epoxy coated cast aluminum handle
- Easily converted for cartridges and sachets
- Switchable Pressure Relief Device (PRD)

BENEFITS

- For day long comfortable use
- Gives you complete flexibility
- Prevents material run-on

APPLICATIONS



Bonding

Sealing

PRODUCT BY RANGE



PowerFlow
HP Cartridge

PowerFlow
HP Combi

PowerFlow
HP Quart

THE POWERFLOW COMBI HP 1-COMPONENT MANUAL DISPENSER IS DESIGNED FOR USE WITH MEDIUM TO HIGH VISCOSITY SEALANTS AND ADHESIVES COMPATIBLE WITH BOTH CARTRIDGES AND SACHETS FOR COMPLETE FLEXIBILITY.

SPECIFICATIONS

- Weight: 0.9–1.1 kg / 2.0–2.3 lbs
- Barrel Length: 274–382 mm / 10.8–15.0 in
- Maximum Thrust: 3.5 kN
- Handle Material: Epoxy Coated Aluminum
- Barrel Material: Anodized Aluminum / Clear Plastic
- Cartridge Capacity: 310 mL (10.5 oz), 400 mL (13.5 oz)
- Sachet Capacity: 310 mL (10.5 oz), 400 mL (13.5 oz), 600 mL (20.3 oz)
- Mechanical Advantage Ratio: (18:1)
- Standard Color: Black/Grey
- Nozzle Dimension: Ø 38 mm / 1.5 in
- Customized versions on demand

DIMENSIONS (MM/IN)

product	height (h)	length (l)	depth (d)	barrel (b)
Combi 300 HP	213 / 8.4	376 / 14.8	69 / 2.7	274 / 10.8
Combi 400 HP	213 / 8.4	376 / 14.8	69 / 2.7	274 / 10.8
Combi 600 HP	213 / 8.4	493 / 19.4	69 / 2.7	382 / 15.0

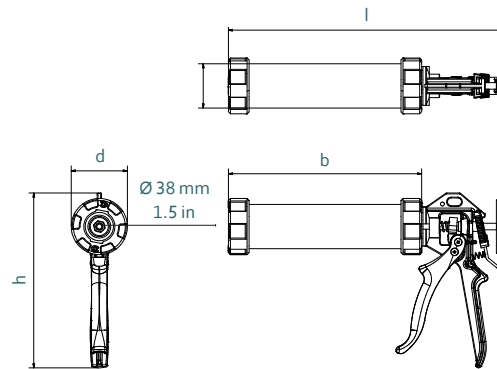

Product	Article number	Packaging
	Anodized Aluminium Barrel	
DM1C 310-cm-r18-001	177319 (51000-XT for US)	10 per Box (1 per Box for US)
DM1C 400-cm-r18-001	177327 (51000-400XT for US)	10 per Box (1 per Box for US)
DM1C 600-cm-r18-001	177351 (51001-XT for US)	10 per Box (1 per Box for US)

MATCHING MIXPAC™ CARTRIDGES



Peeler Cartridge

COMPATIBLE CARTRIDGES AND SACHETS

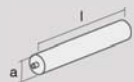

Plastic Cartridge
310 mL HPDE/PP/PA

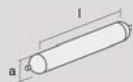

Sachet
310 mL

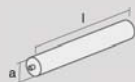

Plastic Cartridge
400 mL HPDE/PA

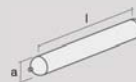

Sachet
400 mL

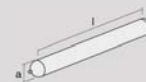

Sachet
600 mL

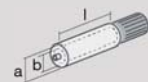

Plastic Cartridge
150 mL 1:1, 2:1, 10:1 PP

	mm	inch	mm	inch	mm	inch	mm	inch	mm	inch	mm	inch	
l	216.0	8.5	220.0	8.66	256.0	10.1	258.0	10.16	335.0	13.2	117	4.6	
a	Ø 48.2	Ø 1.8	Ø 50.0	Ø 1.97	Ø 49.0	Ø 1.9	Ø 50.0	Ø 1.97	Ø 50.0	Ø 2.0	Ø 50.0	Ø 1.9	
											1:1 b	Ø 32.0	Ø 1.2
											2:1 b	Ø 26.0	Ø 1.0
											10:1 b	Ø 14.3	Ø 0.5

CONVERSION KITS

G2 Bulk Plunger / Peeler Front Cap

MATCHING ACCESSORIES

Nozzle extension / Twisty nozzle / White Cone / Yellow Cone / Orange Cone on pages 98–102.