

# POWERFLOW™ COMBI

## 310–600 ML CARTRIDGE & SACHET DISPENSER



Model shown: PowerFlow Combi 600 mL

### FEATURES

- High quality epoxy coated cast aluminum handle
- Anodized aluminum barrel
- Switchable Pressure Relief Device (PRD)
- Contoured handle and trigger grip

### BENEFITS

- Lightweight and highly durable
- Easily converted from cartridge to sachet
- Prevents material run-on
- For ease of use

### APPLICATIONS

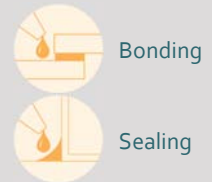

### PRODUCT BY RANGE

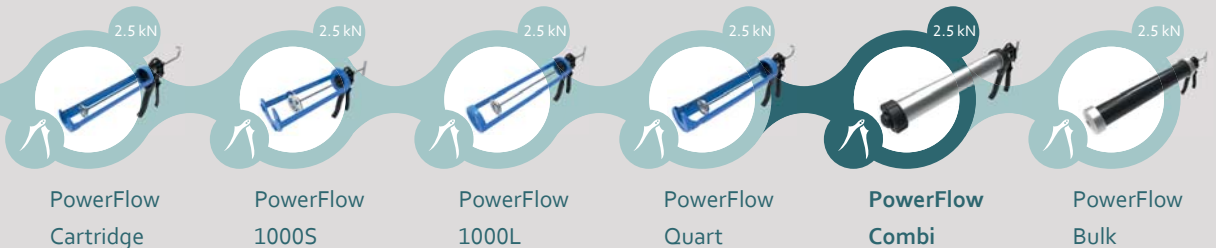

# THE POWERFLOW COMBI 1-COMPONENT MANUAL DISPENSER DESIGNED FOR USE WITH LOW TO MEDIUM VISCOSITY SEALANTS AND COMPATIBLE WITH BOTH CARTRIDGES AND SACHETS.

## SPECIFICATIONS

- Weight: 0.9–1.1 kg / 2.0–2.3 lbs
- Barrel Length: 236–389 mm / 9.3–15.3 in
- Maximum Thrust: 2.5 kN
- Handle Material: Epoxy Coated Aluminum
- Barrel Material: Anodized Aluminum
- Barrel Type: Anodized Aluminum / Clear Plastic
- Cartridge Capacity: 310 mL (10.5 oz), 400 mL (13.5 oz)
- Sachet Capacity: 310 mL (10.5 oz), 400 mL (13.5 oz), 600 mL (20.3 oz)
- Mechanical Advantage Ratio: (12:1)
- Standard Color: Black/Grey
- Nozzle Dimension: Ø 38 mm / 1.5 in
- Customized versions on demand

## DIMENSIONS (MM/IN)

product	height (h)	length (l)	depth (d)	barrel (b)
Combi 310	213 / 8.4	337 / 13.3	69 / 2.7	236 / 9.3
Combi 400	213 / 8.4	381 / 14.7	69 / 2.7	282 / 11.1
Combi 600	213 / 8.4	488 / 19.0	69 / 2.7	389 / 15.3

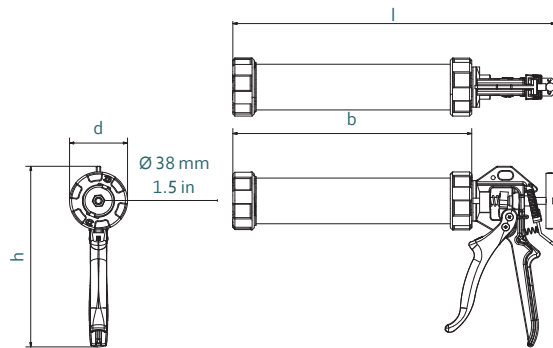

Product	Article number	Packaging
	Anodized Aluminium Barrel	Clear Plastic Barrel
DM1C 310-cm-r12-021	177312 / 51000 (for US)	-
DM1C 310-cm-r12-001	177313	-
DM1C 310-cm-r12-101	-	177315
DM1C 400-cm-r12-002	177328 / 51000-400 (for US)	-
DM1C 400-cm-r12-001	177329	-
DM1C 400-cm-r12-101	-	177331
DM1C 600-cm-r12-052	177353	-
DM1C 600-cm-r12-001	177354	-
DM1C 600-cm-r12-101	-	177356

## MATCHING MIXPAC™ CARTRIDGES



Peeler Cartridge

## COMPATIBLE CARTRIDGES AND SACHETS

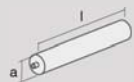

Plastic Cartridge  
310 mL HPDE/PP/PA

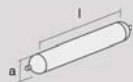

Sachet  
310 mL

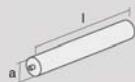

Plastic Cartridge  
400 mL HPDE/PA

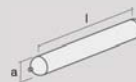

Sachet  
400 mL

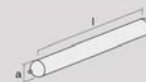

Sachet  
600 mL

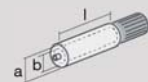

Plastic Cartridge  
150 mL 1:1, 2:1, 10:1 PP

	mm	inch	mm	inch	mm	inch	mm	inch	mm	inch	mm	inch	
l	216.0	8.5	220.0	8.66	256.0	10.1	258.0	10.16	335.0	13.2	117	4.6	
a	Ø 48.2	Ø 1.8	Ø 50.0	Ø 1.97	Ø 49.0	Ø 1.9	Ø 50.0	Ø 1.97	Ø 50.0	Ø 2.0	Ø 50.0	Ø 1.9	
											1:1 b	Ø 32.0	Ø 1.2
											2:1 b	Ø 26.0	Ø 1.0
											10:1 b	Ø 14.3	Ø 0.5

## CONVERSION KITS

Peeler Front Cap

## MATCHING ACCESSORIES

Nozzle extension / Twisty nozzle / White Cone / Yellow Cone / Orange Cone nozzle / Ladder Hook Kit on pages 98–102.