

# MIDIFLOW™ COMBI

## 310–600 ML CARTRIDGE & SACHET DISPENSER

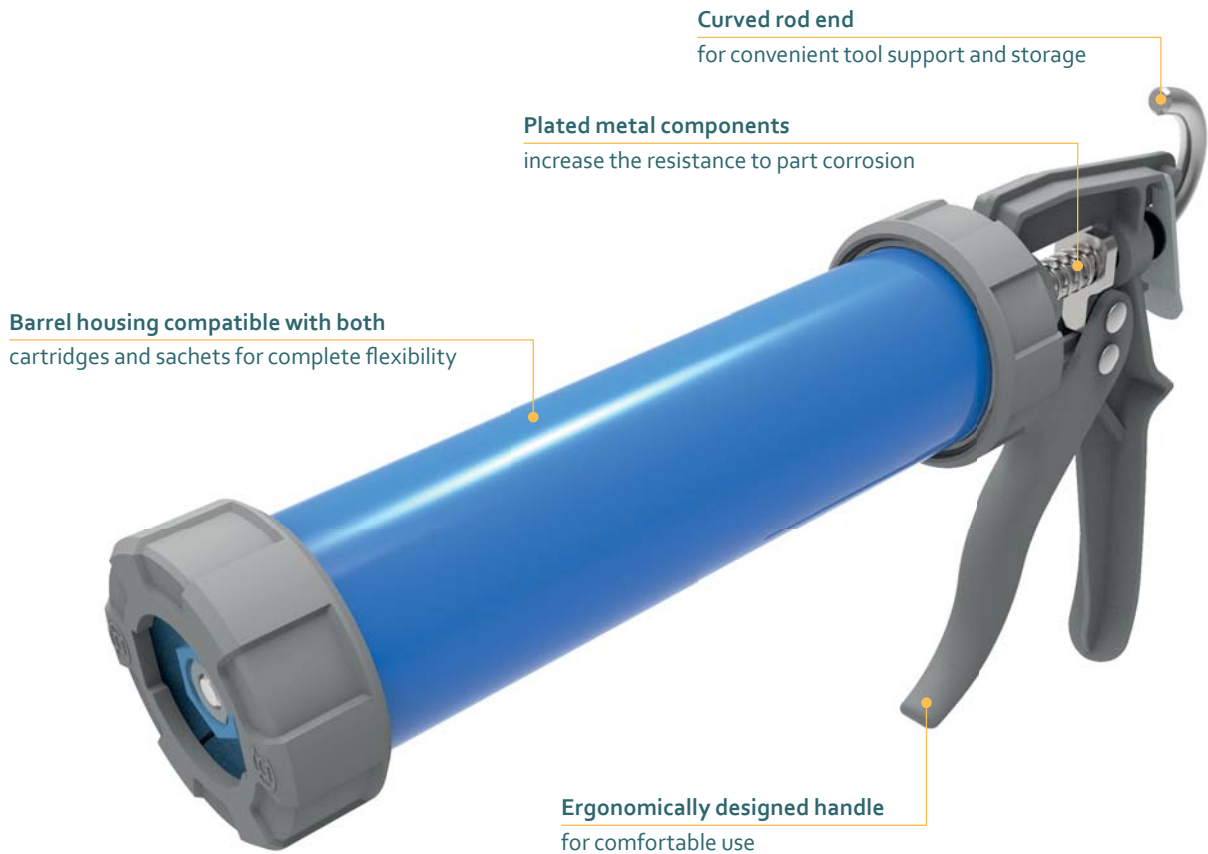

Model shown: MidiFlow Combi 600 mL

### FEATURES

- Ergonomically designed handle
- Barrel housing for cartridges and sachets
- Curved rod end
- Surface hardened catch plate and rod design

### BENEFITS

- Lightweight highly durable
- Gives you complete flexibility
- For convenient tool support and storage
- Maintains high material output

### APPLICATIONS



### PRODUCT BY RANGE

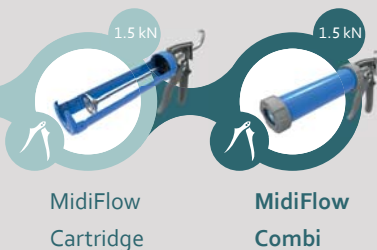

# THE MIDIFLOW COMBI 1-COMPONENT MANUAL DISPENSER IS COMPATIBLE WITH BOTH CARTRIDGES AND SACHETS ALLOWING THE USER COMPLETE FLEXIBILITY BETWEEN SEALANT SYSTEMS.

## SPECIFICATIONS

- Weight: 0.58 kg / 1.3 lbs
- Barrel Length: 377 mm / 14.84 in
- Maximum Thrust: 1.5 kN
- Handle Material: Glass Fiber Reinforced Nylon
- Barrel Material: ABS Polymer
- Cartridge Capacity: 310 mL (10.5 oz), 400 mL (13.5 oz)
- Sachet Capacity: 310 mL (10.5 oz), 400 mL (13.5 oz), 600 mL (20.3 oz)
- Mechanical Advantage Ratio: (10:1)
- Standard Color: Blue/Grey
- Nozzle Dimension: Ø 38 mm / 1.5 in
- Customized versions on demand

## DIMENSIONS

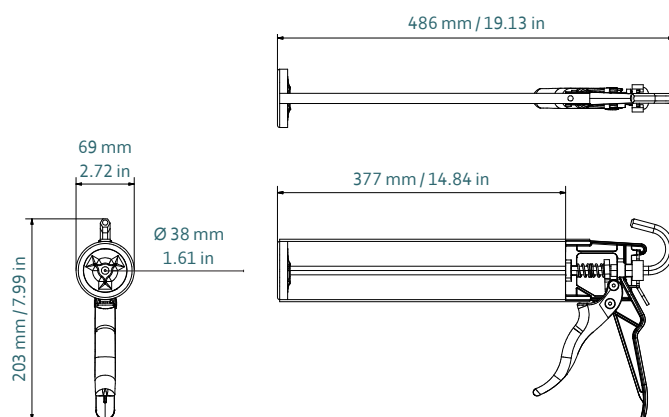

Product	Article number	Packaging
DM1C 600-cm-r10-001	159906 (31001-600 for US)	10 per Box (3 per Box for US)

## MATCHING MIXPAC™ CARTRIDGES

## COMPATIBLE CARTRIDGES AND SACHETS

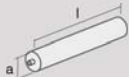
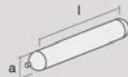
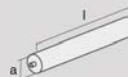
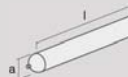
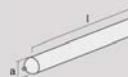
	mm		inch	
	Plastic Cartridge 310 mL HPDE/PP/PA			
l	216.0	8.5		
a	Ø 48.2	Ø 1.8		
	Sachet 310 mL			
l	220.0	8.66		
a	Ø 50.0	Ø 1.97		
	Plastic Cartridge 400 mL HPDE/PA			
l	256.0	10.0		
a	Ø 49.0	Ø 1.9		
	Sachet 400 mL			
l	258.0	10.16		
a	Ø 50.0	Ø 1.97		
	Sachet 600 mL			
l	335.0	13.19		
a	Ø 50.0	Ø 1.97		

## CONVERSION KITS

## MATCHING ACCESSORIES

Nozzle extension / twisty nozzle / yellow cone / white cone / orange cone nozzle on pages 98–102.